

For use with Security+ 2.0™ Garage Door Openers. All Security+ 2.0™ Garage Door Openers have a yellow Learn button and two yellow antennas. The features are adjustable and may be turned off or on as desired. Refer to the Feature Settings section.

## Feature Overview

### LIGHT BUTTON

Press the LIGHT button to turn the garage door opener lights on or off. When the lights are turned on they will stay on until the LIGHT button is pressed again, or until the garage door opener is activated. Once the garage door opener is activated the lights will turn off after the specified period of time (the factory setting is 4-1/2 minutes). The LIGHT button will not control the lights when the door is in motion.

### MOTION SENSOR

The motion sensor will automatically turn on the garage door opener lights when motion is detected. The lights will come on for the set period of time, then shut off. The factory setting is on and set at 4-1/2 minutes.

### LOCK

The LOCK feature is designed to prevent activation of the garage door opener from remote controls while still allowing activation from the door control and keyless entry. This feature is useful for added peace of mind when the home is empty (i.e. vacation).

### MAINTENANCE ALERT SYSTEM (MAS)

This feature assists the homeowner in ensuring the garage door opener system stays in good working condition. The MAS feature **MUST** be activated at time of installation. The factory setting is off. The service LED will come on after 4500 garage door opener cycles. This indicates the garage door opener may need maintenance; contact your installation dealer. If the MAS feature is activated, the command LED (yellow) and the service LED (red) will alternate flashing back and forth.

### TIMER-TO-CLOSE (TTC) FOR MODEL 881LM ONLY

DO NOT enable TTC if operating a one-piece door. TTC is to be used **ONLY** with sectional doors. The TTC can be set to automatically close your garage door after a specified period of time (1, 5, or 10 minute intervals). The garage door opener will beep and the lights will flash before closing the door. If the door encounters an obstruction while closing, the garage door opener will make a second attempt to close the door. If the obstruction has not been cleared after the second attempt, the garage door opener will reverse open, stop and **WILL NOT** close until the obstruction has been cleared. TTC **WILL NOT** work if the garage door opener is operating by battery power or if the safety reversing sensors are misaligned. This feature is **NOT** intended to be the primary method of closing the door. **A keyless entry should be installed in the event of an accidental lock out when using this feature.**

NOTICE: To comply with FCC and or Industry Canada rules (IC), adjustment or modifications of this receiver and/or transmitter are prohibited, except for changing the code setting or replacing the battery. **THERE ARE NO OTHER USER SERVICEABLE PARTS.**

Tested to Comply with FCC Standards for Home or office use. Operation is subject to the following two conditions: (1) this device may not cause harmful interference, and (2) this device must accept any interference received, including interference that may cause undesired operation.

This Class B digital apparatus complies with Canadian ICES-003.  
Cet appareil numérique de la classe B est conforme à la norme NMB-003 du Canada.

## ⚠️ WARNING

To prevent possible **SERIOUS INJURY** or **DEATH** from electrocution:

- Be sure power is **NOT** connected **BEFORE** installing door control.
- Connect **ONLY** to 12 VOLT low voltage wires.

To prevent possible **SERIOUS INJURY** or **DEATH** from a closing garage door:

- Install door control within sight of garage door, out of reach of children at a minimum height of 5 feet (1.5 m), and away from **ALL** moving parts of door.
- **NEVER** permit children to operate or play with door control push buttons or remote control transmitters.
- Activate door **ONLY** when it can be seen clearly, is properly adjusted, and there are no obstructions to door travel.
- **ALWAYS** keep garage door in sight until completely closed. **NEVER** permit anyone to cross path of closing garage door.

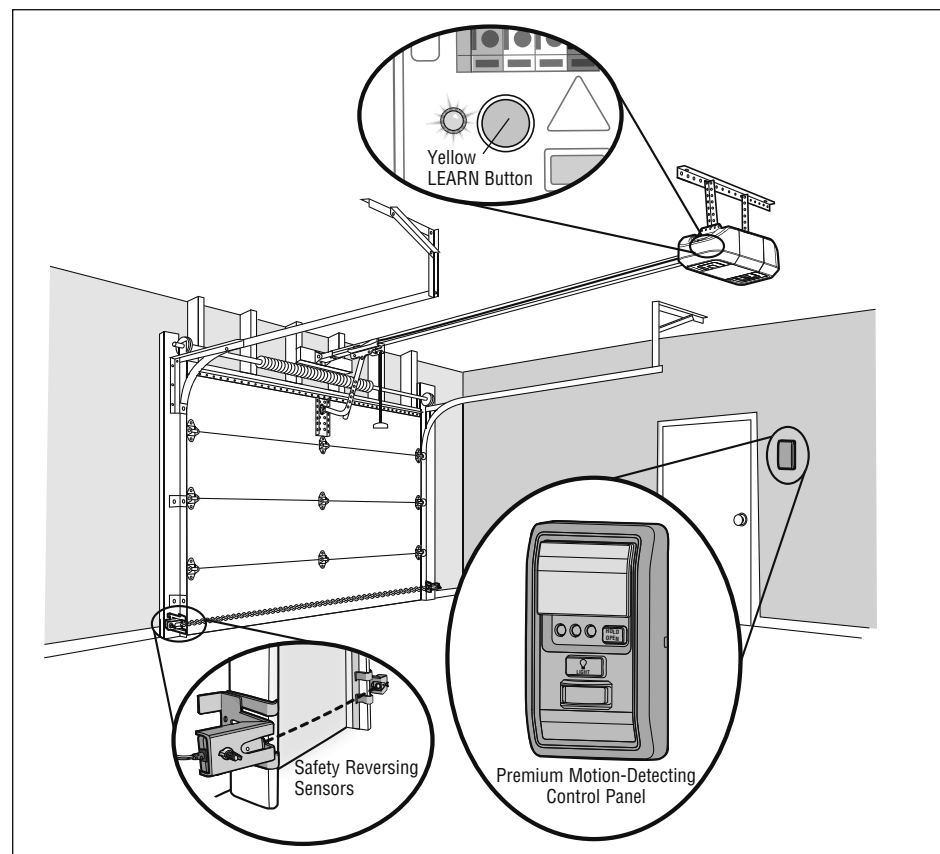

# Installation

Install the door control within sight of the door at a minimum height of 5 feet (1.5 m) where small children cannot reach, and away from the moving parts of the door. For gang box installations it is not necessary to drill holes or install the drywall anchors. Use the existing holes in the gang box.

**NOTE:** Pre-wiring means that your garage already has wires installed for the door control.

## HARDWARE

### DRYWALL

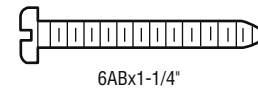

### GANG BOX

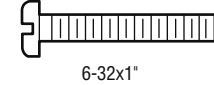

## WIRE THE DOOR CONTROL

- 1 Unplug the garage door opener to ensure the door control cannot be activated during wiring.

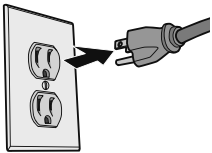

- 2 Strip 7/16" (11 mm) of insulation from one end of the wire and separate the wires.

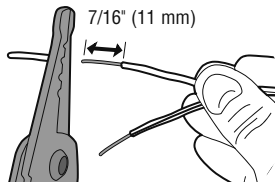

- 3 Connect the wire to both screws on the back of the door control. The wires can be connected to either screw.

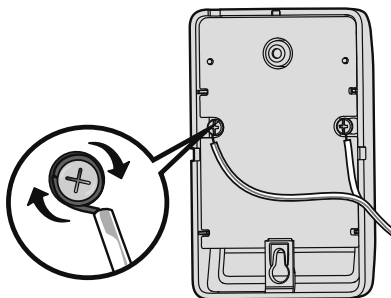

**PRE-WIRED INSTALLATIONS:** Choose any two wires to connect, but make note of which wires are used.

## MOUNT THE DOOR CONTROL

- 1 Mark the location of the bottom mounting hole and drill a 5/32" (4 mm) hole.
- 2 Install the bottom screw, allowing 1/8" (3 mm) to protrude from the wall.
- 3 Position the bottom hole of the door control over the screw and slide down into place.

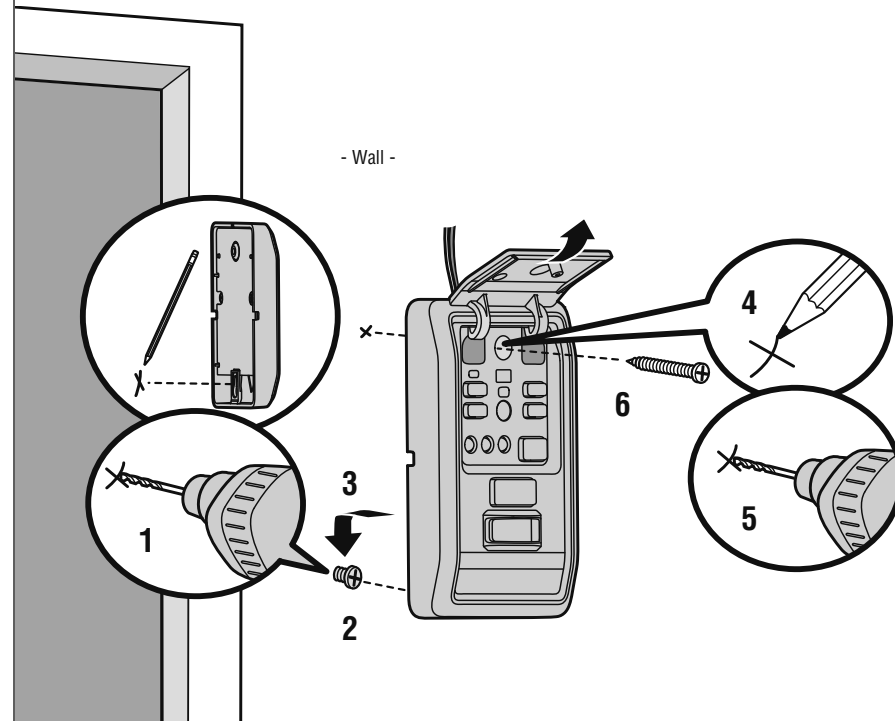

- 4 Lift the push bar up and mark the top hole.
- 5 Remove the door control from the wall and drill a 5/32" (4 mm) hole for the top screw.
- 6 Position the bottom hole of the door control over the screw and slide down into place. Attach the top screw.

## WIRE TO GARAGE DOOR OPENER

- 1 Strip 7/16" (11 mm) of insulation from the end of the wire near the garage door opener.

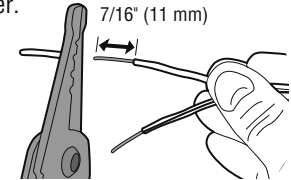

- 2 Connect the wire to the red and white terminals on the garage door opener. The wires can be connected to either terminal.

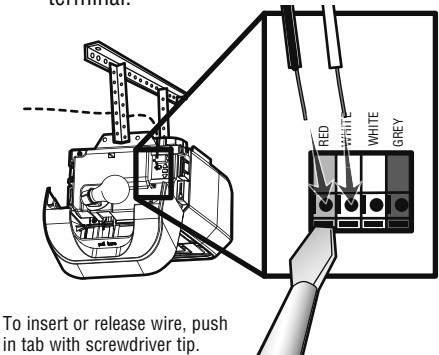

To insert or release wire, push in tab with screwdriver tip.

**PRE-WIRED INSTALLATIONS:** Connect the same wires to the garage door opener that were previously connected to the door control.

- 3 Reconnect power to the garage door opener. The command LED behind the push bar on the door control will blink if installed correctly. To synchronize the garage door opener and the door control, press the push bar up to 3 times. Press until the garage door opener activates.

# Operation

## PUSH BAR

Press the push bar to open/close the door.

## GARAGE DOOR OPENER LIGHTS

Press the LIGHT button to turn the garage door opener lights on or off. When the lights are turned on they will stay on until the LIGHT button is pressed again, or until the garage door opener is activated. Once the garage door opener is activated the lights will turn off after the specified period of time (the factory setting is 4-1/2 minutes). The LIGHT button will not control the lights when the door is in motion.

## MOTION SENSOR

This feature will automatically turn on the garage door opener lights when motion is sensed. The lights will come on for the set period of time, then shut off.

## LIGHT FEATURE

The lights will turn on when someone enters through the open garage door and the safety reversing sensor infrared beam is broken.

If using the garage door opener light as a work light, turn the light on using the light button on the wall control or the light will turn off if you are beyond the range of the sensor.

## TIMER-TO-CLOSE (TTC) 881LM ONLY

DO NOT enable TTC if operating a one-piece door. TTC is to be used ONLY with sectional doors.

The TTC can be turned on or off and the time interval can be adjusted to 1, 5, and 10 minute intervals. Once the TTC has been set and the door is open, the selected close interval will blink and begin to count down to close the door. The garage door opener will beep and the lights will flash before closing the door.

To temporarily suspend the TTC feature press and release the HOLD OPEN button (the HOLD OPEN button will light solid). Press the HOLD OPEN button again to resume normal TTC operation.

The TTC feature will deactivate if the garage door encounters an obstruction twice; or the safety reversing sensors are incorrectly installed. The garage door will reverse open and WILL NOT close until the obstructions are clear or the safety reversing sensors are correctly installed. When the obstruction has been cleared or the safety reversing sensors have been aligned, the door will close when the garage door opener is activated.

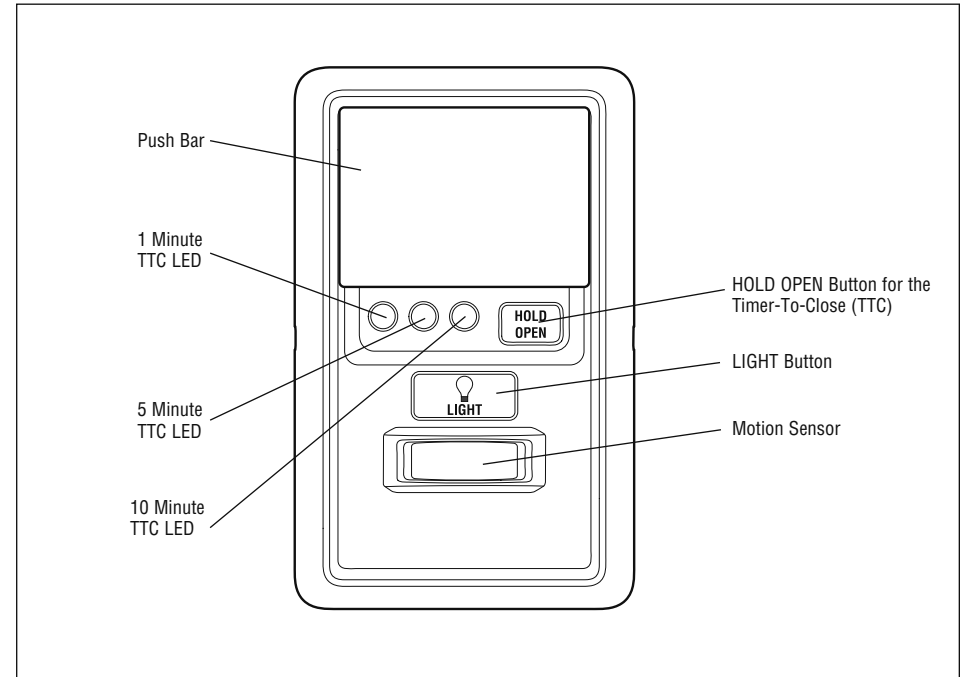

# Program

## TO ADD, REPROGRAM, OR CHANGE A REMOTE CONTROL/KEYLESS ENTRY PIN

**1** Press the LEARN button on the door control to enter Programming Mode.

The command LED will flash once.

**2** Press the LEARN button again, the LED will flash once.

The command LED will flash once again.

**3a** Press the button on the remote control that you wish to operate your garage door.

**OR**

**3b** Enter a 4-digit personal identification number (PIN) of your choice on the keyless entry keypad. Then press the ENTER button.

The garage door opener lights will flash (or two clicks will be heard) when the code has been programmed. Repeat the steps above for programming additional remote controls or keyless entry devices.

# Feature Settings

## TIMER-TO-CLOSE (TTC) 881LM ONLY

**NOTE:** DO NOT enable TTC if operating a one-piece door. TTC is to be used ONLY with sectional doors.

### Activate:

Press and hold the ON button until one of the TTC LEDs light up.

Then press the ON button again to cycle through the time interval options (the corresponding TTC LED will light for each time interval). The garage door opener light bulbs will blink as confirmation.

### Deactivate:

Press and hold the OFF button until all TTC LEDs turn off and a beep is heard from the motor unit.

### Temporarily hold door open (suspend TTC):

Press and release the HOLD OPEN button. Press the HOLD OPEN button again to resume normal TTC operation.

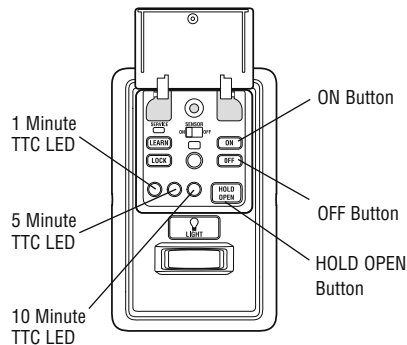

**NOTE:** If you have an 880LM installed and the TTC is set to a custom time, the 3 LED's on the 881LM will blink. If the 3 LED's are blinking and you have an 881LM ONLY, press the ON button to set the time properly.

## LOCK

### Activate:

Press and hold the LOCK button for 2 seconds. The command LED will flash as long as the lock feature is activated and your handheld remote control will not operate your door at this time.

### Deactivate:

Press and hold the LOCK button again for 2 seconds. The command LED will stop flashing and normal operation will resume.

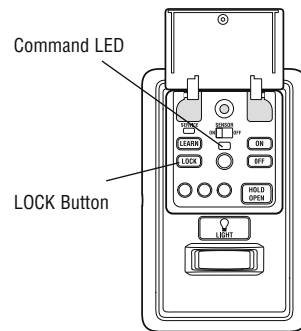

## LIGHT

### To change the amount of time the garage door opener lights will stay on:

Press and hold the LOCK button until the garage door opener lights flash.\* The time interval is indicated by the number of flashes.

NUMBER OF TIMES GARAGE DOOR OPENER LIGHTS FLASH	TIME THE GARAGE DOOR OPENER LIGHT STAYS ON
1	1 ½ Minutes
2	2 ½ Minutes
3	3 ½ Minutes
4	4 ½ Minutes

To cycle through the time intervals repeat the step above.

### LIGHT FEATURE

#### Deactivate:

Press and hold the LIGHT button until the garage door opener lights turn on, then off again.\*

#### Activate:

Start with the garage door opener lights on. Press and hold the LIGHT button until the garage door opener lights turn off, then on again.\*

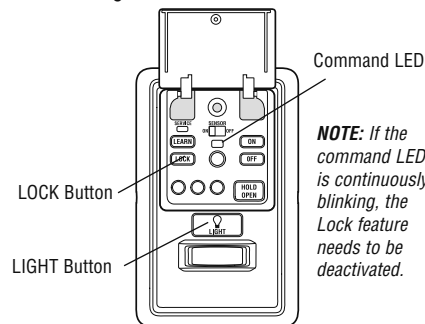

**NOTE:** If the command LED is continuously blinking, the Lock feature needs to be deactivated.

\* Approximately 10 seconds

## MOTION SENSOR

### Activate/Deactivate:

Slide the motion sensor switch ON or OFF.

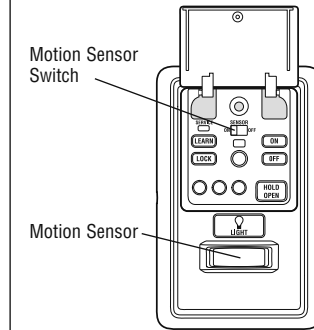

## MAINTENANCE ALERT SYSTEM (MAS)

### Activate/Deactivate:

Press and hold the LEARN button. Then press the LIGHT button. The service LED will flash the status; Active is 2 flashes and deactivated is 3 flashes.

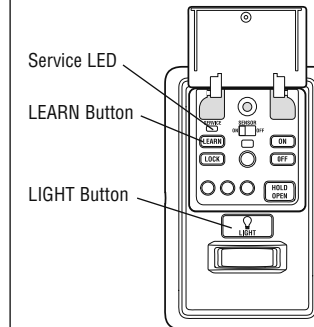

# Warranty

## ONE YEAR LIMITED WARRANTY

The Chamberlain Group, Inc. warrants to the first consumer purchaser of this product that is free from defect in materials and/or workmanship for a period of 1 year from the date of purchase.

© 2011, The Chamberlain Group, Inc.  
All Rights Reserved

FOR SERVICE DIAL OUR TOLL FREE NUMBER:

1-800-528-9131

www.liftmaster.com